

VALIANT COMMUNICATIONS LIMITED

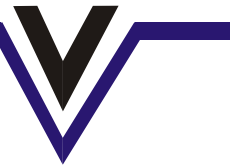

VCL-8/16 x T1 Over Ethernet Multiplexer (TDM Over IP)

Product Brochure & Data Sheet

INDIA

Valiant Communications Limited

71/1, Shivaji Marg, New Delhi - 110015, India
Phone: +91-11 4105 5601, +91-11 4105 5602,
+91-11 4105 5603, +91-11 2592 8415,
Fax: +91-11 4105 5604, +91-11 2543 4300
E-mail: getinfo@valiantcom.com
Website: <http://www.valiantcom.com>

U.K.

Valiant Communications (UK) Ltd

1, Acton Hill Mews, 310-328 Uxbridge Road,
London W3 9QN
United Kingdom
E-mail: uk@valiantcom.com
Website: <http://www.valiantcom.com>

U.S.A.

Valcomm Technologies Inc.

4000 Ponce de Leon, Suite 470
Coral Gables, FL 33146
United States of America
E-mail: fl@valiantcom.com
Website: <http://www.valiantcom.com>

U.A.E.

Valiant Communications FZE

P.O. Box No. 121523 SAIF Zone,
Sharjah,
U.A.E.
E-mail: uae@valiantcom.com
Website: <http://www.valiantcom.com>

Description

The VCL-8/16 x T1 over Ethernet multiplexer (TDM over IP) product supports transportation of 8 T1 or 16 T1s and 5 GE electrical ports and 1 GE optical port. The uplink ports and user data ports are IEEE 802.3 compliant, 10/100/1000M auto-sensing Ethernet ports.



VCL-8/16 x T1 Over Ethernet Multiplexer (TDM over IP)

The state-of-art design provides the highest availability with the accurate timing signal and data bit stream reconstruction.

Telecom and Enterprise users can save a lot of equipment costs and generates new revenue by offering different types of services over their packet-switched infrastructure. It is also suitable for connecting to the wireless equipment to achieve fast deployment of T1 services. One particular application is to build T1 links with low cost Wireless LAN bridges, replacing much more costly microwave radios. Operators can use VCL- 8/16 x T1 over Ethernet multiplexer (TDM over IP) to provide legacy TDM services over wired or wireless Ethernet/IP network.

Application Diagram

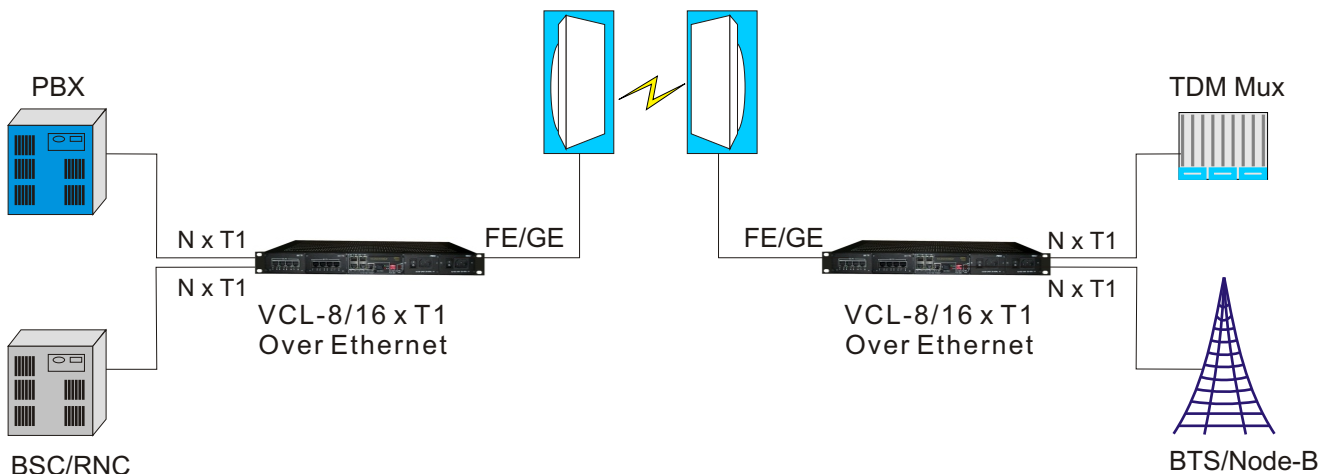

(A) Typical Application in Wireless Network

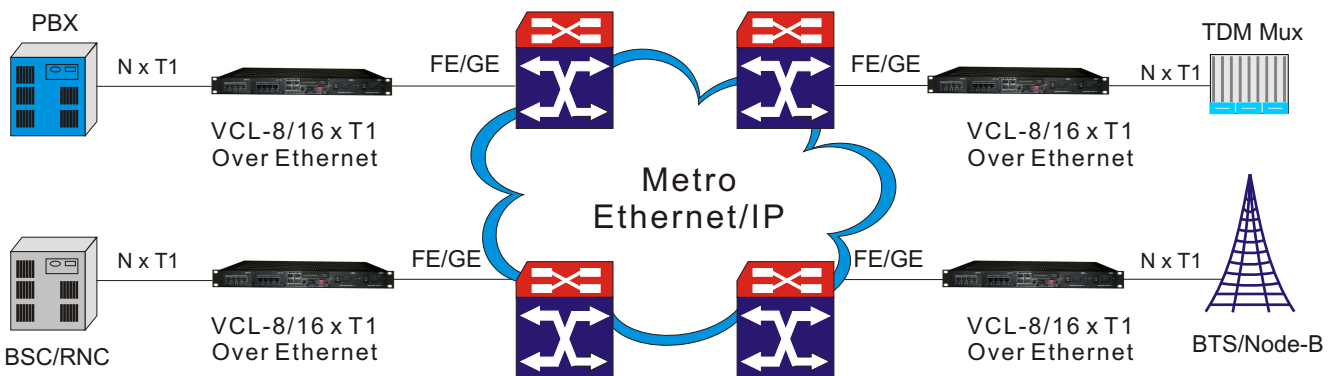

(B) Typical Application in Wired Network





Features

- Provides 8 T1 or 16 T1s ports
- Provides 5 GE electrical ports and 1 GE optical port 6 GE ports serve as network uplinks or users ports of the 5 GE electrical ports may act as Management Port
- User-friendly Web server supported for easy setup and maintenance, Alarm logs provided
- Support Ethernet spanning tree protocol which enable normal work and protection in ring and mesh topology
- Support SNMP V1/V2 network management
- Ethernet built-in layer 2 switch, supports VLAN, complies with IEEE 802.3x, 802.1P
- Provide two pluggable T1 cards, each card supports 8 T1s
- Point to point and point to multipoint application supported
- Stable T1 clock recovery, low jitter and wander
- Low processing delay for T1 channels, high bandwidth usage efficiency
- PCM frame synchronization protection
- User definable encapsulation packet size for different applications
- Support Ethernet encapsulation and UDP/IP protocol encapsulation
- Support VLAN settings for T1 service and in-band VLAN management
- Jitter buffer for packet delay variation (PDV)
- Local Ethernet port throughput limit assuring T1 QoS
- 100Ω balanced T1 port, RJ-45 connector
- Supports 75Ω unbalanced port (optional extra)
- Support cascade concatenate for more than 16 T1 ports
- Online Upgrade for software and hardware
- - 48 V DC Power supply redundancy

Technical Specifications

Item	Description	
Model	VCL- 8/16 x T1 Over Ethernet Multiplexer (TDM Over IP)	5 GE electrical ports and 1 GE optical port, upto 16 T1s
Interfaces	IP Ports	5 GE electrical ports and 1 GE optical port Comply with IEEE 802.3, 802.1Q, 802.1P Speed and duplex auto-negotiation or manual
	T1 Ports	8 T1 Ports supported 16 T1s Ports supported Comply with G.703 Impedance: T1-100Ω or 75Ω (optional extra)
Management Port	Same as IP Ports	Web server and SNMP management supported
Power	Power Supply	Pluggable dual power supply
		2 x - 48 V DC or DC+AC
		-48V~-72V DC or 100 ~ 240V AC
	Consumption	≤15W
Working Environment	Temperature	0~ 50°C
	Relative Humidity	≤ 90% (non-condensing)
Dimension	W x H x D (mm)	440 x 44 x 231 (1U height)

Interoperability Table with Wireless Bridges

LOGO	Manufacturer	Place	Model
	MOTOROLA	USA	CANOPY PTP600, 500, 400, 300, 100 series (Formerly Canopy 10/20M, 30/60M, 150/300M Backhaul Modules).
	Alvarion	Israel	BreezeNET Series B100, DS.11 etc, BreezeAccess Series LB etc .
	Proxim	USA	Tsunami™, QuickBridge20 series Tsunami™ MP.11 Series
	Firepro Wireless	India	Firepro Wireless all series
	Infinet Wireless	Russia	SkyMan NG

Note: The series TDM over IP products have excellent interoperability which could work with most of prevailing wireless bridges. .

Technical specifications are subject to change without notice.
Revision 04 - March 10, 2010

INDIA

Valiant Communications Limited

71/1, Shivaji Marg, New Delhi - 110015, India
Phone: +91-11 4105 5601, +91-11 4105 5602,
+91-11 4105 5603, +91-11 2592 8415,
Fax: +91-11 4105 5604, +91-11 2543 4300
E-mail: getinfo@valiantcom.com
Website: <http://www.valiantcom.com>

U.K.

Valiant Communications (UK) Ltd

1, Acton Hill Mews, 310-328 Uxbridge Road,
London W3 9QN
United Kingdom
E-mail: uk@valiantcom.com
Website: <http://www.valiantcom.com>

U.S.A.

Valcomm Technologies Inc.

4000 Ponce de Leon, Suite 470
Coral Gables, FL 33146
United States of America
E-mail: fl@valiantcom.com
Website: <http://www.valiantcom.com>

U.A.E.

Valiant Communications FZE

P.O. Box No. 121523 SAIF Zone,
Sharjah,
U.A.E.
E-mail: uae@valiantcom.com
Website: <http://www.valiantcom.com>